



■ Features

- 4"x2" compact size
- Medical safety approved (2 x MOPP) according to ANSI/AAMI ES60601-1 and IEC/EN60601-1
- Suitable for BF application with appropriate system consideration
- 84W convention, 120W force air
- EMI Class B for both Class I (with FG) & Class II (no FG) configuration
- No load power consumption < 0.3W
- Extremely low leakage current
- 12V/0.5A fan supply
- Protections: Short circuit / Overload / Over voltage / Over temperature
- 3 years warranty

■ Applications

- Oral irrigator
- Hemodialysis machine
- Medical monitors
- Sleep apnea devices
- Pumps machine

■ Description

RPS-120 is a 120W highly reliable green PCB type medical power supply with a high power density on a 4" by 2" footprint. It accepts 80~264VAC input and offers various models with the output voltages between 12V and 48V. The working efficiency is up to 91% and the extremely low no load power consumption is down below 0.3W. RPS-120 is able to be used for both Class I (with FG) or Class II (no FG) system design. The extremely low leakage current is less than 150 μ A. In addition, it conforms to the international medical regulations (2*MOPP) and EMC EN55011, perfectly fitting all kinds of BF rated "patient contact" medical system equipment.

■ Model Encoding

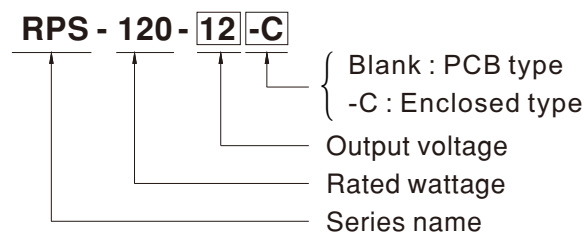

SPECIFICATION

| MODEL | | RPS-120-12□ | RPS-120-15□ | RPS-120-24□ | RPS-120-27□ | RPS-120-48□ | |
|---------------------------|---|---|--------------|--|--------------|--|-------|
| OUTPUT | DC VOLTAGE | 12V | 15V | 24V | 27V | 48V | |
| | CURRENT | 10CFM | 10A | 8A | 5A | 4.5A | 2.5A |
| | | Convection | 7.0A | 5.6A | 3.5A | 3.15A | 1.75A |
| | RATED POWER | 10CFM | 120W | 120W | 120W | 121.5W | 120W |
| | | Convection | 84W | 84W | 84W | 85W | 84W |
| | RIPPLE & NOISE (max.) Note.2 | 100mVp-p | 120mVp-p | 150mVp-p | 150mVp-p | 150mVp-p | |
| | VOLTAGE ADJ. RANGE | 11.4~12.6V | 14.3~15.8V | 22.8~25.2V | 25.6 ~ 28.4V | 45.6 ~50.4V | |
| | VOLTAGE TOLERANCE Note.3 | ±2.0% | ±2.0% | ±1.0% | ±1.0% | ±1.0% | |
| | LINE REGULATION | ±0.5% | ±0.5% | ±0.5% | ±0.5% | ±0.5% | |
| | LOAD REGULATION | ±1.0% | ±1.0% | ±1.0% | ±1.0% | ±1.0% | |
| SETUP, RISE TIME | 500ms, 30ms/230VAC 500ms, 30ms/115VAC at full load | | | | | | |
| HOLD UP TIME (Typ.) | 50ms/230VAC 10ms/115VAC at full load | | | | | | |
| INPUT | VOLTAGE RANGE Note.4 | 80 ~ 264VAC | 113 ~ 370VDC | | | | |
| | FREQUENCY RANGE | 47 ~ 63Hz | | | | | |
| | EFFICIENCY (Typ.) | 89% | 89% | 90% | 90% | 91% | |
| | AC CURRENT (Typ.) | 2.1A/115VAC 1.2A/230VAC | | | | | |
| | INRUSH CURRENT (Typ.) | COLD START 30A/115VAC 60A/230VAC | | | | | |
| | LEAKAGE CURRENT(max.) Note.5 | Earth leakage current < 150µA/264VAC , Touch current < 80µA/264VAC | | | | | |
| PROTECTION | OVERLOAD | 115~150% rated output power Protection type : Hiccup mode, recovers automatically after fault condition is removed | | | | | |
| | OVER VOLTAGE | 13.2 ~ 15.6V | 16.5 ~ 19.5V | 26.4 ~ 31.2V | 29.7 ~ 35V | 52.8 ~ 62.4V | |
| | OVER TEMPERATURE | Protection type : Shut down o/p voltage, re-power on to recover | | | | | |
| FUNCTION | FAN SUPPLY | 12V@0.5A for driving a fan ; tolerance -15% ~ +10% | | | | | |
| ENVIRONMENT | WORKING TEMP. | -30 ~ +70°C (Refer to "Derating Curve") | | | | | |
| | WORKING HUMIDITY | 20 ~ 90% RH non-condensing | | | | | |
| | STORAGE TEMP., HUMIDITY | -40 ~ +85°C , 10 ~ 95% RH non-condensing | | | | | |
| | TEMP. COEFFICIENT | ±0.03%/°C (0 ~ 50°C) | | | | | |
| | VIBRATION | 10 ~ 500Hz, 2G 10min./1cycle, 60min. each along X, Y, Z axes | | | | | |
| | OPERATING ALTITUDE Note.6 | 4000 meters | | | | | |
| SAFETY & EMC (Note 7) | SAFETY STANDARDS | IEC60601-1, TUV EN60601-1, UL ANSI / AAMI ES60601-1 (3.1 version), CAN/CSA-C22.2 No. 60601-1:14 - Edition 3 approved; Design refer to EN60335-1 | | | | | |
| | ISOLATION RESISTANCE | Primary-Secondary: 2xMOPP, Primary-Earth: 1xMOPP, Secondary-Earth: 1xMOPP | | | | | |
| | WITHSTAND VOLTAGE | I/P-O/P: 4KVAC I/P-FG: 2KVAC O/P-FG: 1.5KVAC | | | | | |
| | ISOLATION RESISTANCE | I/P-O/P, I/P-FG: 100M Ohms / 500VDC / 25°C / 70% RH | | | | | |
| | EMC EMISSION | Parameter | | Standard | | Test Level / Note | |
| | | Conducted emission | | EN55011 (CISPR11) | | Class B | |
| | | Radiated emission | | EN55011 (CISPR11) | | Class B | |
| | | Harmonic current | | EN61000-3-2 | | Class A | |
| | | Voltage flicker | | EN61000-3-3 | | ----- | |
| | EMC IMMUNITY | EN60601-1-2 | | | | | |
| | | Parameter | | Standard | | Test Level / Note | |
| | | ESD | | EN61000-4-2 | | Level 4, 15KV air ; Level 4, 8KV contact | |
| | | RF field susceptibility | | EN61000-4-3 | | Level 3, 10V/m(80MHz~2.7GHz) Table 9, 9~28V/m(385MHz~5.78GHz) | |
| | | EFT bursts | | EN61000-4-4 | | Level 3, 2KV | |
| Surge susceptibility | | EN61000-4-5 | | Level 4, 4KV/Line-FG; 2KV/Line-Line | | | |
| Conducted susceptibility | | EN61000-4-6 | | Level 3, 10V | | | |
| Magnetic field immunity | | EN61000-4-8 | | Level 4, 30A/m | | | |
| Voltage dip, interruption | | EN61000-4-11 | | 100% dip 1 periods, 30% dip 25 periods, 100% interruptions 250 periods | | | |
| OTHERS | MTBF | 653.5Khrs min. MIL-HDBK-217F (25°C) | | | | | |
| | DIMENSION (L*W*H) | PCB: 101.6*50.8*29mm or 4" * 2" * 1.14" inch ; Enclosed type: 103.4*62*40mm or 4.07" * 2.44" * 1.57" inch | | | | | |
| | PACKING | PCB: 0.15Kg; 72pcs/11.8Kg/0.82CUFT ; Enclosed type: 0.24Kg; 60pcs/15.4Kg/1.12CUFT | | | | | |
| NOTE | <p>1. All parameters NOT specially mentioned are measured at 230VAC input, rated load and 25 of ambient temperature.</p> <p>2. Ripple & noise are measured at 20MHz of bandwidth by using a 12" twisted pair-wire terminated with a 0.1µf & 47µf parallel capacitor.</p> <p>3. Tolerance : includes set up tolerance, line regulation and load regulation.</p> <p>4. Derating may be needed under low input voltages. Please check the derating curve for more details.</p> <p>5. Touch current was measured from primary input to DC output.</p> <p>6. The ambient temperature derating of 5°C/1000m is needed for operating altitude greater than 2000m (6500ft).</p> <p>7. The power supply is considered a component which will be installed into a final equipment. All the EMC tests are been executed by mounting the unit on a 360mm*360mm metal plate with 1mm of thickness. The final equipment must be re-confirmed that it still meets EMC directives. For guidance on how to perform these EMC tests, please refer to "EMI testing of component power supplies." (as available on http://www.meanwell.com)</p> | | | | | | |

Block Diagram

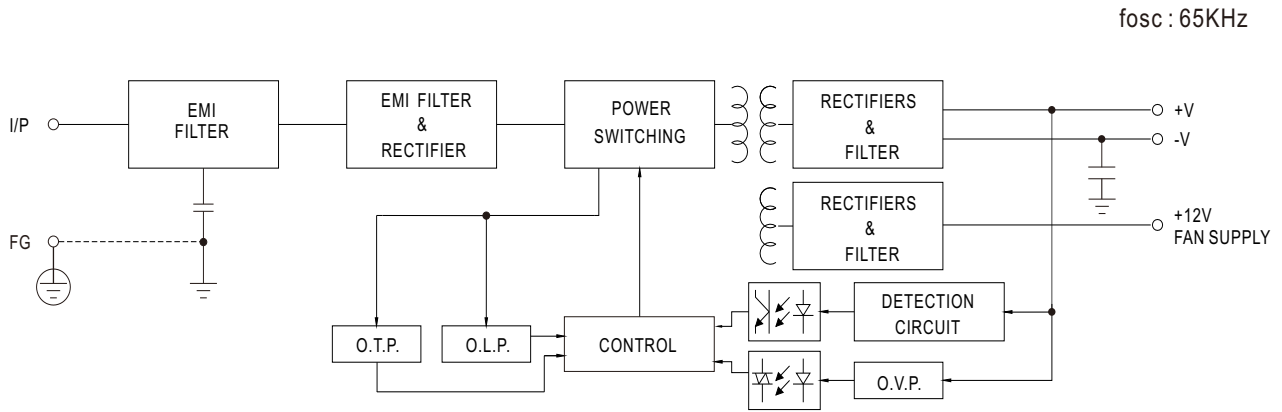

Derating Curve

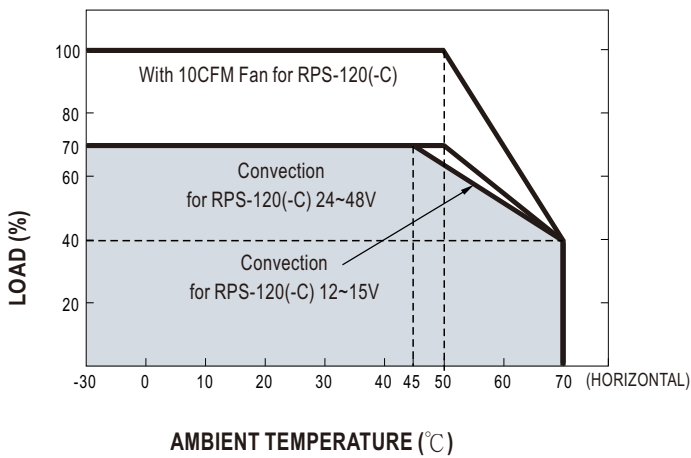

Output Derating VS Input Voltage

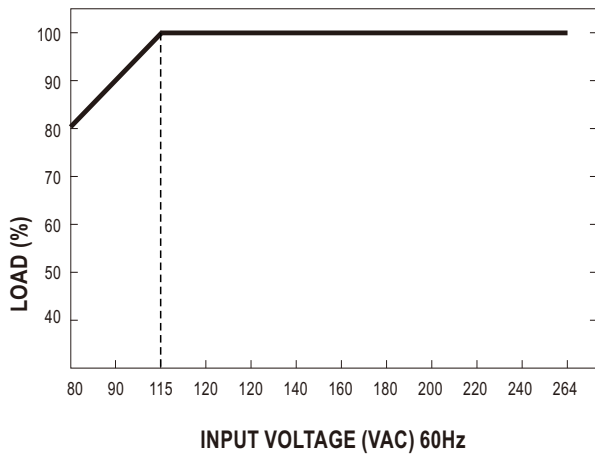

■ Mechanical Specification

● RPS-120 (PCB Type)

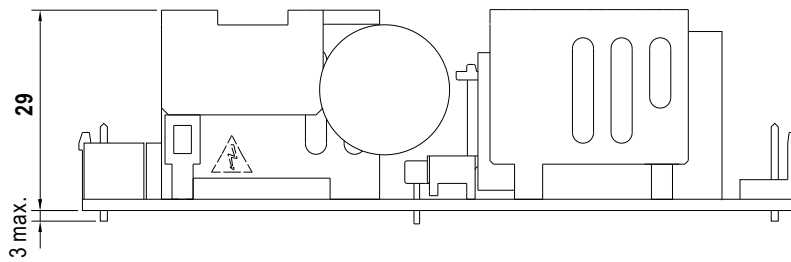
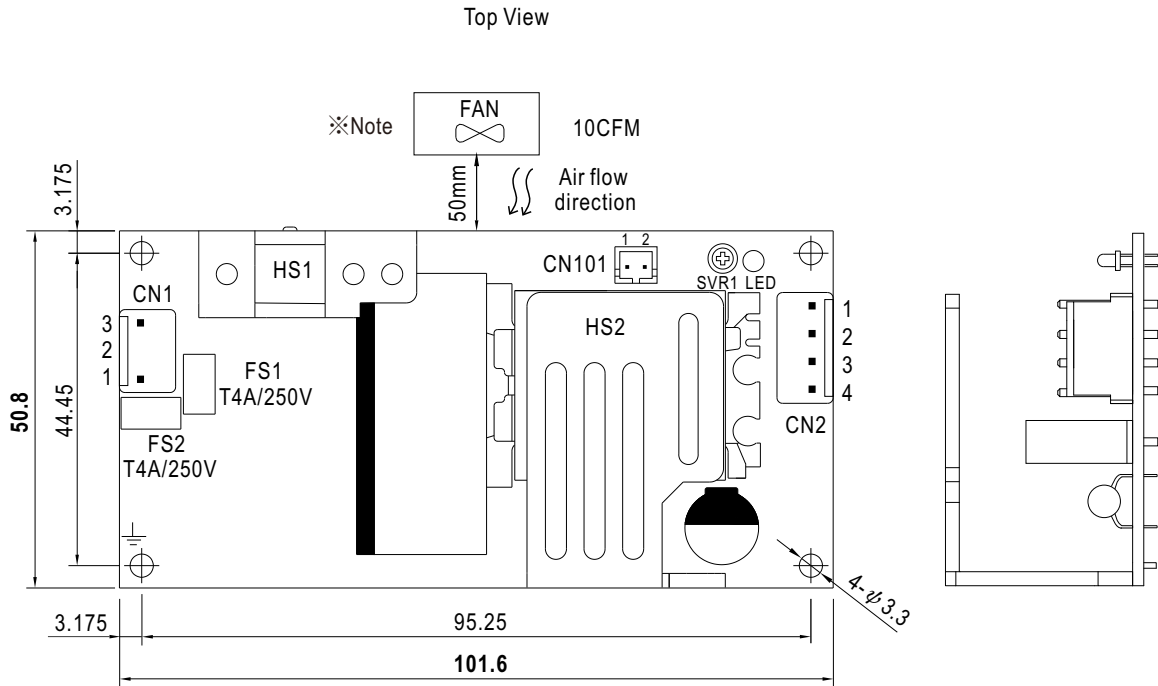

Side View

■ Mechanical Specification

● RPS-120-C (Enclosed Type)

Case No.245A Unit:mm

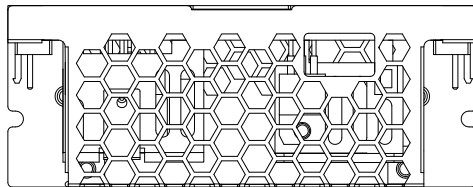

Side View

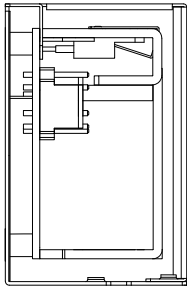
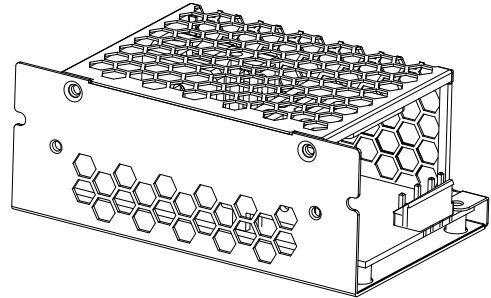

Side View

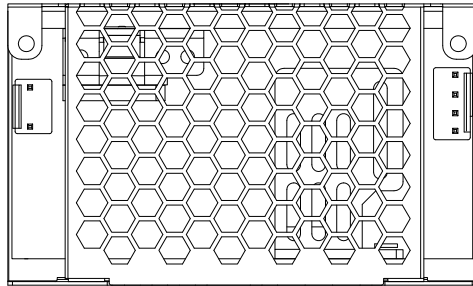

Top View

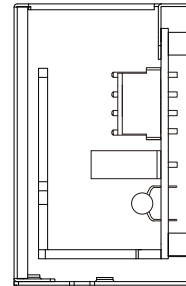

Side View

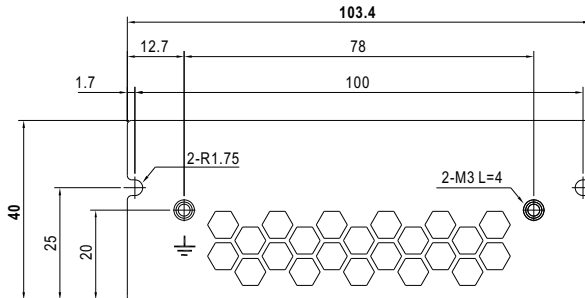

Side View

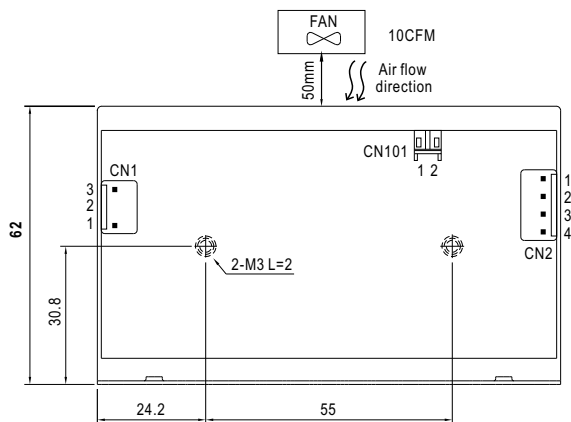

Bottom View

AC Input Connector (CN1) : JST B3P-VH or equivalent

| Pin No. | Assignment | Mating Housing | Terminal |
|---------|------------|--------------------------|-----------------------------------|
| 1 | AC/N | JST VHR or equivalent | JST SVH-21T-P1.1 or equivalent |
| 2 | No Pin | | |
| 3 | AC/L | | |

DC Output Connector (CN2) : JST B4P-VH or equivalent

| Pin No. | Assignment | Mating Housing | Terminal |
|---------|------------|--------------------------|-----------------------------------|
| 1,2 | +V | JST VHR or equivalent | JST SVH-21T-P1.1 or equivalent |
| 3,4 | -V | | |

FAN Connector(CN101) : JST S2B-PH-K-S or equivalent

| Pin No. | Assignment | Mating Housing | Terminal |
|---------|--------------|----------------------------|-------------------------------------|
| 1 | DC COM(FAN-) | JST PHR-2 or equivalent | JST SPH-002T-P0.5S or equivalent |
| 2 | +12V(FAN+) | | |

- ⚠ 1.HS1,HS2 cannot be shorted.
2.HS1 must have safety isolation distance with system case.

- ※Note : 1. The FAN supply is designed to serve as the source of the additive external fan for the cooling of the power supply, enabling the full load delivery and assuring the best life span of the product. Please do not use this FAN supply to drive other devices.
2.The PCB type(Blank type)model delivers EMI Class B for both conducted emission and radiated emission for the power supply, when configured into either Class I (with FG) or Class II (no FG) system.
3.The Enclosed type(-C type) model is not suitable for the configuration within a Class II (no FG) system but is suggested to used within a Class I (with FG) system.

■ **Installation Manual**

Please refer to : <http://www.meanwell.com/manual.html>